



**CATALOGO GENERALE RESTAURO**

Autoricambizen - Borgo Musiletto, 90-94 - 35013 Cittadella PD  
Tel: 0495970885 - [info@autoricambizen.com](mailto:info@autoricambizen.com)

# INDICE:

## Guarnizioni:

- Guarnizioni a bulbo laterale 3
- Guarnizioni a bulbo superiore 6
- Copribordi animati e PVC 7
- Guarnizioni cristallo 8
- Canaline scorri vetro 9
- Gomma spugna 10
- Gomma spugna adesiva e gomma cruda 11
- Contorno mascherina - parafanghi autocarri d'epoca 11

## Insonorizzanti e lastre:

- Insonorizzanti cabina 12
- Lastre in gomma e PVC 13

## Particolari in gomma:

- Ganci cofano 14
- Impianto elettrico 14
- Tasselli paracolpi autocarri e autocarri d'epoca 15

## Bulbo laterale:

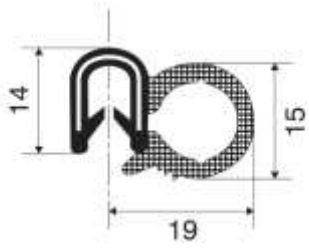

A1

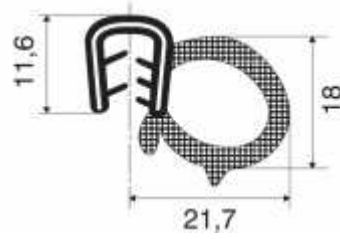

A2.

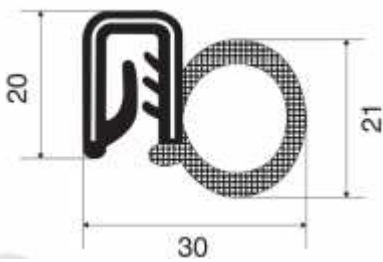

A3

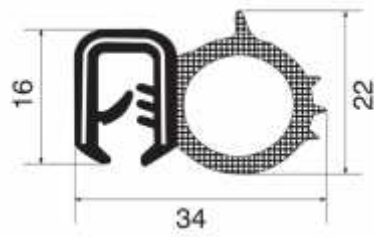

A4

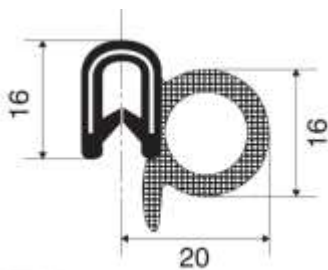

A5

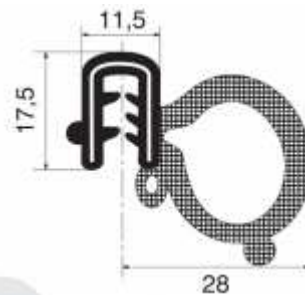

A6

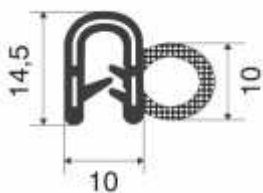

A7.

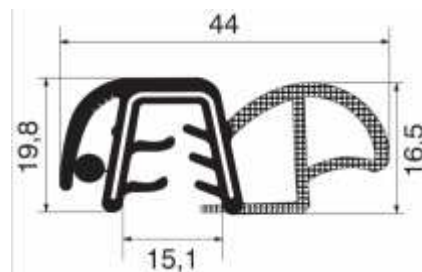

A8

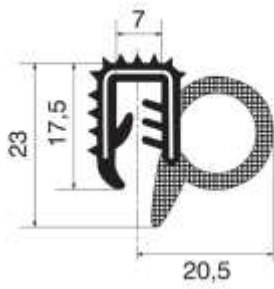

A9

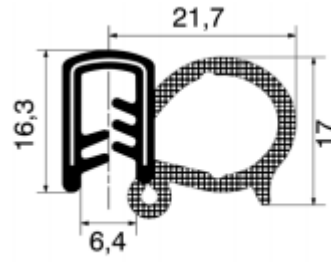

A10

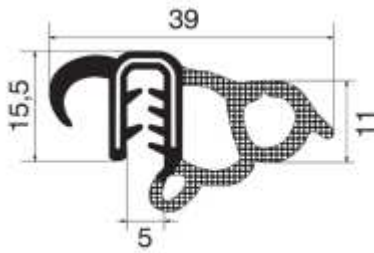

A11

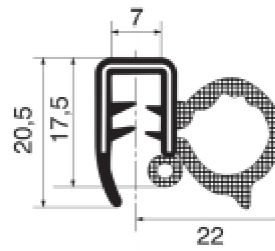

A12

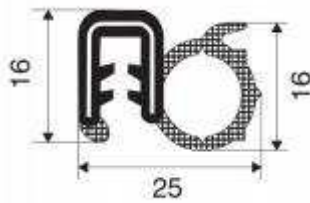

A13

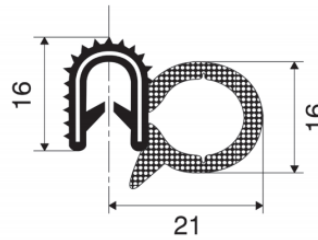

A14

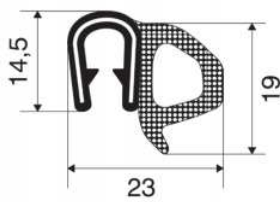

A15

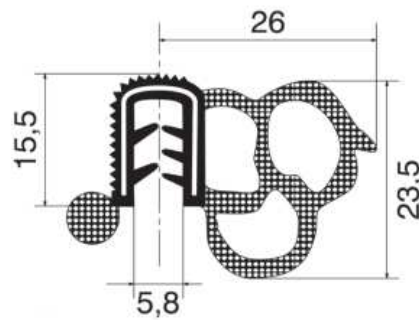

A16

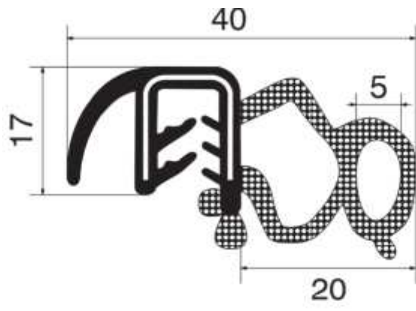

A17

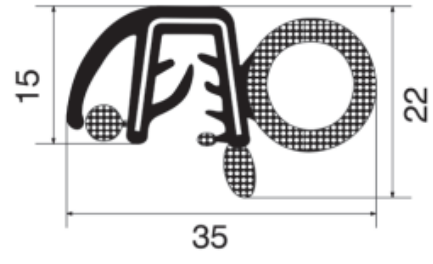

A18

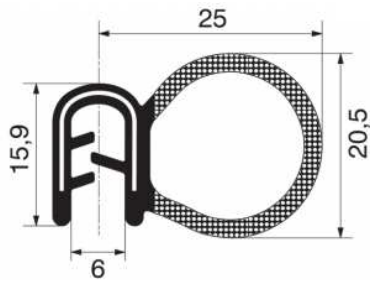

A19

Diam. 12

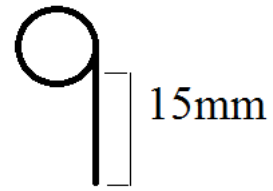

A20

Bulbo superiore:

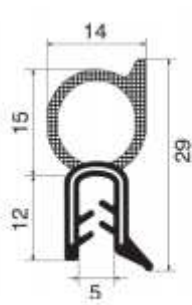

B1



B2

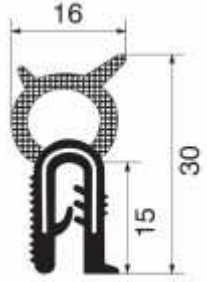

B3



B4



B5



B6

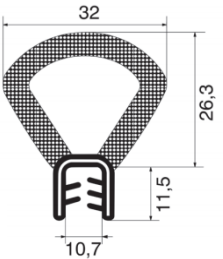

B7

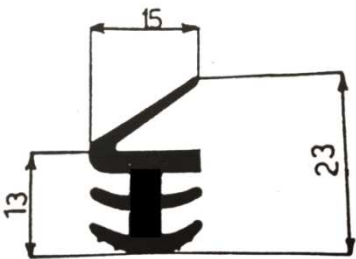

B8



B9

## Copribordi:



C1

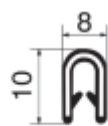

C2

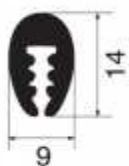

C3

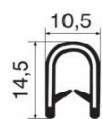

C4

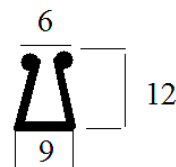

C9

## Copribordi in PVC:

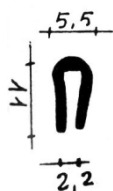

C5



C6

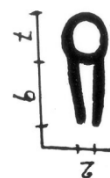

C7

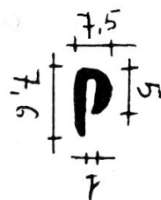

C8

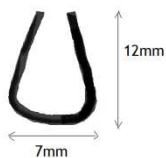

C9 Gomma

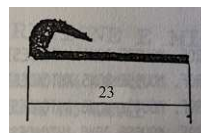

C10

## Guarnizioni cristallo:

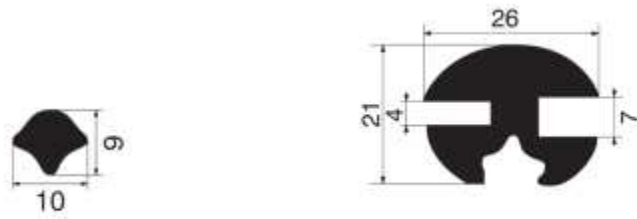

D1 + D2

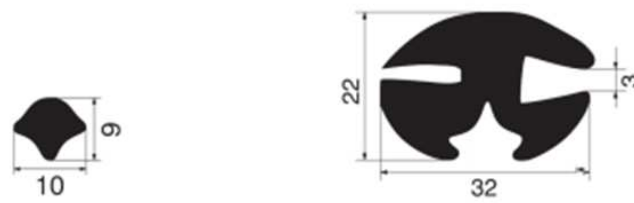

D1 + D3

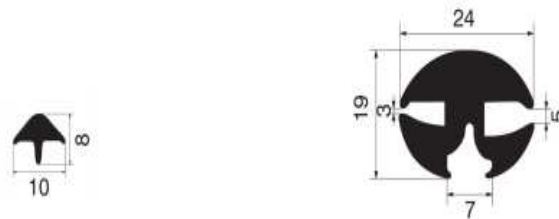

D4 + D5



D6

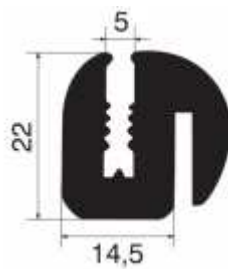

D7

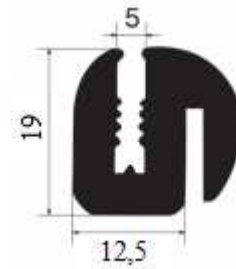

D7-1



## Canaline scorrietro:

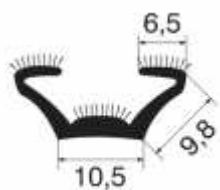

E1

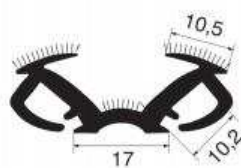

E2



E6

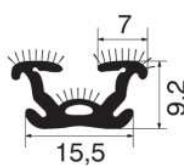

E7

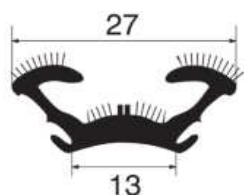

E8

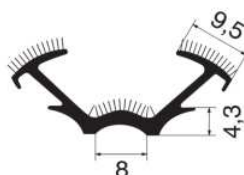

E9

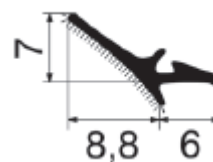

E10

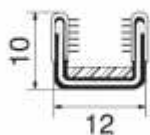

E3

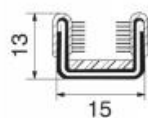

E4

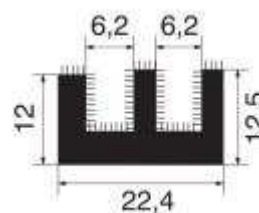

E5

# Gomma spugna:

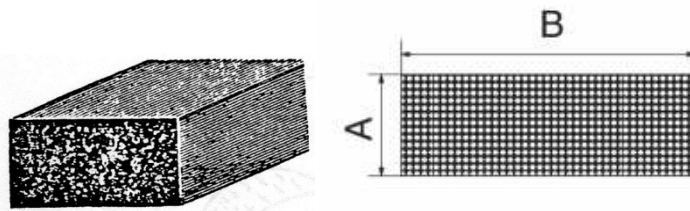

AxB=MM	Codice:
3x30	F 3x30
5x20	F 5x20
5x25	F 5x25
6x20	F 6x20
6x25	F 6x25
8x30	F 8x30
10x30	F 10x30
20x30	F 20x30

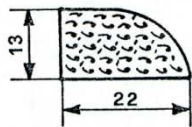

F1

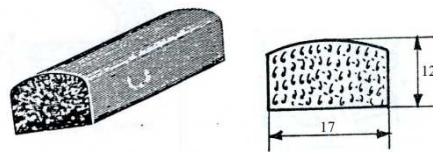

F2

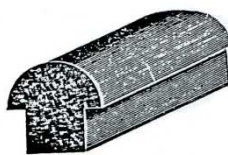

F3

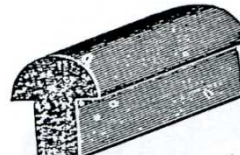
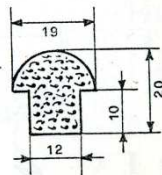

F4

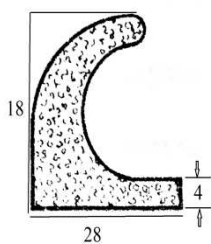
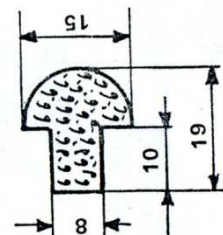

F5

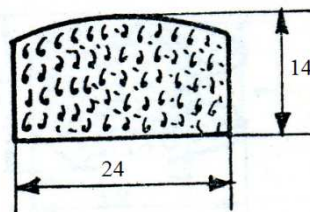

F6

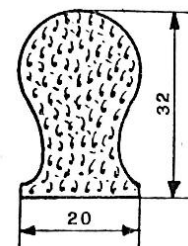

F7

Gomma spugna con adesivo e gomma cruda:

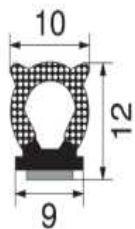

G1

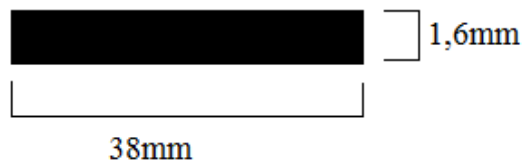

G2

Contorno mascherina,  
parafanghi auto e autocarri d'epoca, fasce serbatoio:



H - Nero

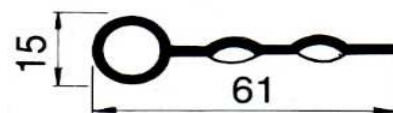

H1

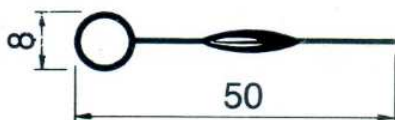

H2

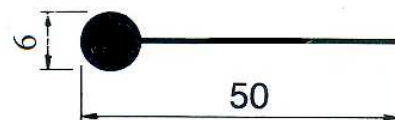

H3 Fintapelle

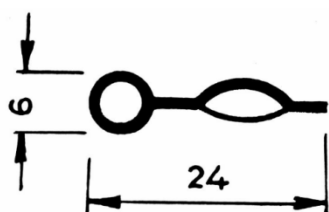

H4

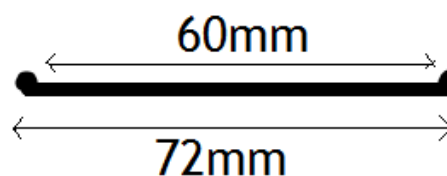

H5

## Insonorizzanti cabina:



**I1:**  
Lastra bugnato adesivizzato 100x50cm



**I2:**  
Lastra antirombo autoadesivo 100x50cm



**I3:**  
Lastra sottocofano accoppiato con alluminio  
100x50cm



**I4:**  
Lastra in juta 100x90cm



**I5:**  
Lastra feltro accoppiato catrame  
specifico per auto d'epoca

## Lastre in gomma e PVC:



**J1:**  
Lastra in PVC BOLLATO H 153cm



**J2:**  
Lastra in PVC millerighe H 140cm



**J3:**  
Lastra in gomma millerighe H 120cm



**J4:**  
Lastra in gomma liscia H 145cm

## Ganci cofano in gomma:



**GC1:** Lungh. 145mm

**GC2:** Lungh. 160mm

**GC3:** Lungh.120mm

**GC4:** Lungh. 65mm



**GC5:** Lungh. 120mm

## Impianto elettrico:

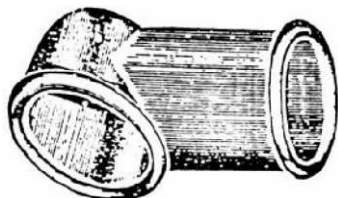

**IE1:** Per motorino avviamento



**IE2:** Per dinamo

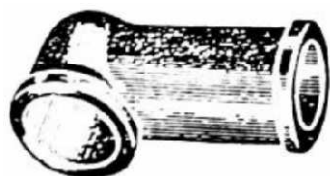

**IE3:** Usi vari

## Tasselli autocarri e autocarri d'epoca:

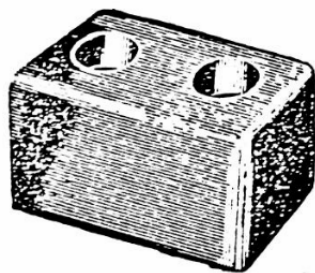

**T1:** con testa superiore piana 48x30mm

**T2:** con testa superiore bombata 48 x30mm

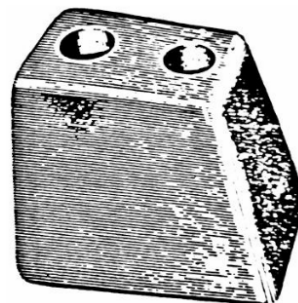

**T3:** Base inf. 60x40mm

Base sup. 50x30mm



**T4:** Diam. Base 25 x H 25mm

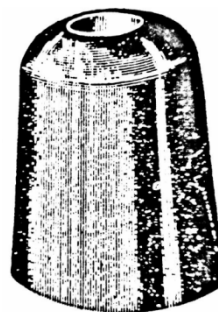

**T5:** h60 50x40mm



**T6:** 29X49mm h13